

名称 NAME	冰箱 REFRIGERATOR					
型号 MODEL	DPCR-400C2X-F6					
尺寸 DIMENSION L×W×H(mm)	电制 VOLTAGE (V/Hz/Ph)	功率 POWER (kW)	最大电流 MAX CURRENT (A)	净重 NET WEIGHT (kg)	容量 CAPACITY (L)	温度范围 TEMPERATURE RANGE (°C)
630×690×1920	220V/1Ph/60Hz	0.45	2.1	115	400	0~+10 -18~0



- 不锈钢材质
- 两门带锁，冷冻和冷藏功能
- 制冷剂:R134A
- 配件包括:冷藏架、钥匙
- 带固定支架

- STAINLESS STEEL FABRICATED
- TWO SWING WITH LOCK, FUNCTION OF FREEZING AND REFRIGERATING
- REFRIGERANT:R134A
- STANDARD ACCESSORIES INCLUDED:FRIDGE RACK, KEYS
- WITH BRACKET FIXED

# 外形图 OUTSIDE DRAWING

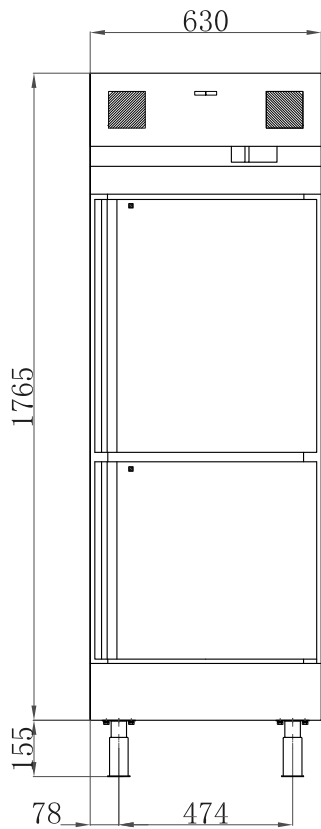

FRONT VIEW

Power line  
(Max1500mm)  
电源线

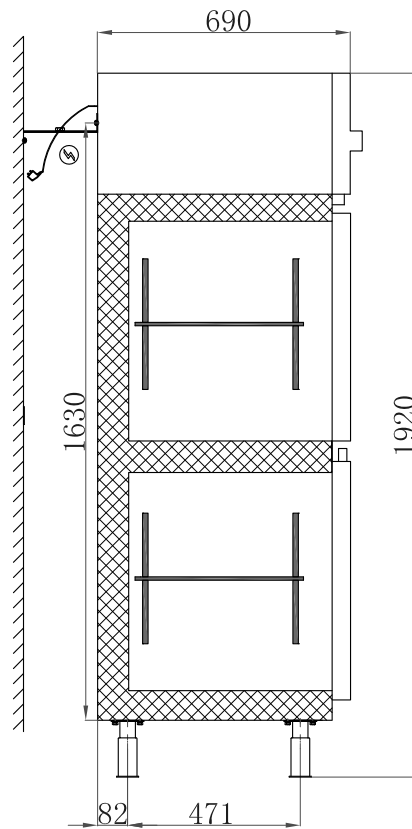

SIDE VIEW

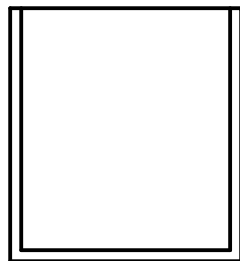

PLAN VIEW

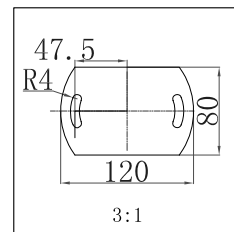

Footing dimensional drawing

				 <b>DMA</b>	<b>丹华海洋工程装备（上海）有限公司</b> <b>DAN MARINE INC.</b>		
					材料 MATERIAL	比例 SCALE	名称 NAME 冰箱
设计 DESIGNED	Jasper	日期 DATE	16.06.01		SUS304	1 : 1	REFRIGERATOR
审阅 CHECKED		日期 DATE			单位 UNIT	视图法 VIEW	型号 MODEL
批准 APPROVED		日期 DATE			mm		DPCR-400C2X-F6

# 安装示意图 INSTALLATION DIAGRAM

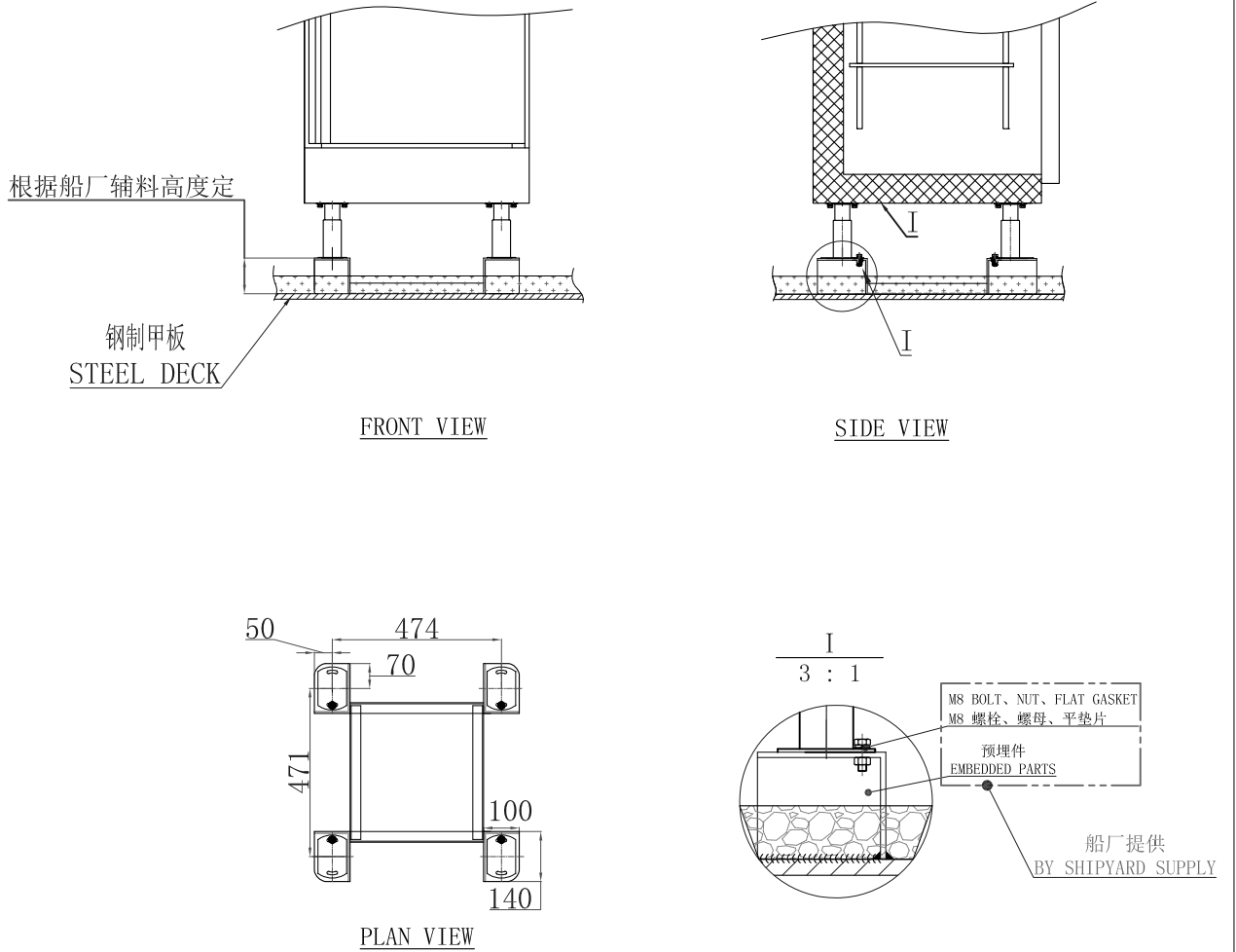

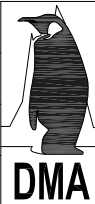
					<b>丹华海洋工程装备（上海）有限公司</b> <b>DAN MARINE INC.</b>					
								材料 MATERIAL	比例 SCALE	名称 NAME
设计 DESIGNED	Jasper	日期 DATE	16.05.24					SUS304	1 : 1	冰箱 REFRIGERATOR
审阅 CHECKED		日期 DATE						单位 UNIT	视图法 VIEW	型号 MODEL DPCR-400C2X-F6
批准 APPROVED		日期 DATE		mm	